

LOCK & HOLD TECHNOLOGY INCLUSIVE THE PM 14/18[®] PROTECTION SYSTEM

Intruder and hurricane protection | Tilt & Turn windows and doors

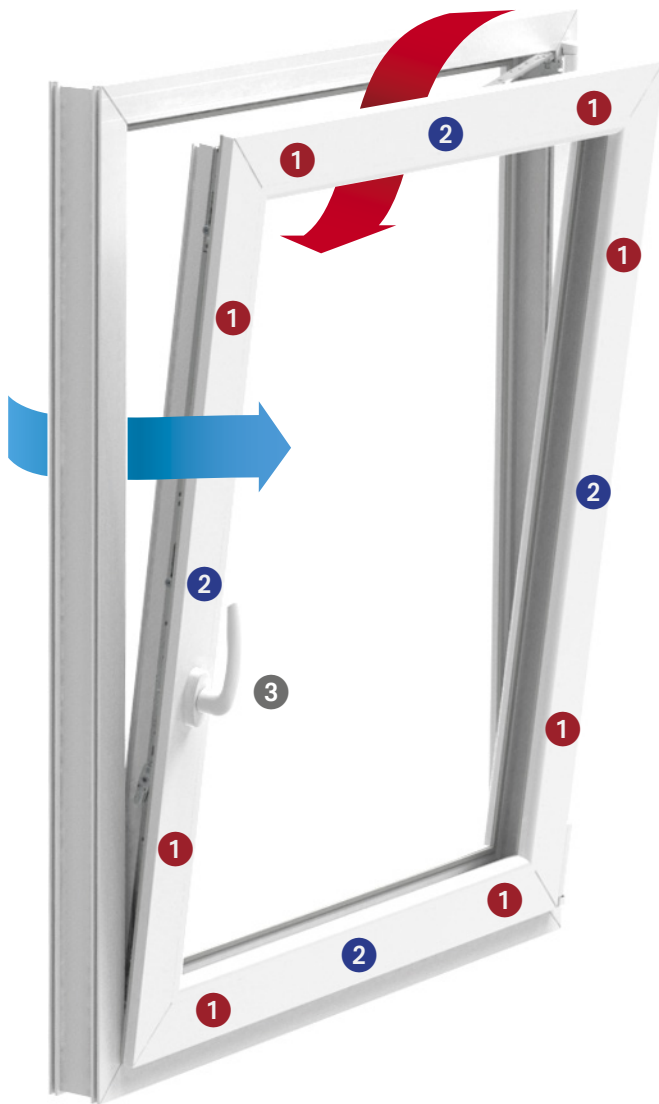

1
14-18 safety bolts

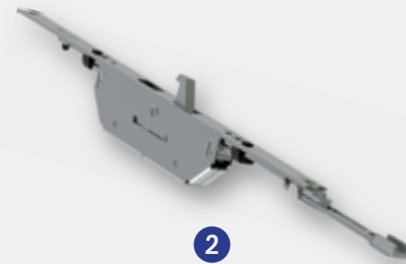

2
2-6 locking claws



3
lockable handle

Energy saving | Noise reducing | One hand operating

PM 14/18[®]
sets are assembled
in more than
74,200
units since 1996

No breach
until today!

PM 14/18[®]

LOCK & HOLD TECHNOLOGY –
FOR YOUR PROTECTION



PM 14/18® | Module 1

Protection standard
for tilt-turn windows and terrace doors



◀ X-Ray Picture
shows invisible
lockings inside of
the frames

The **LOCK & HOLD TECHNOLOGY** with its **PM 14/18®** is our distinctive protection standard in new tilt turn safety windows and terrace doors. Our state of the art technology retrofits both PVC and wooden products into a high performance, breach resistant multi-locking system, including features such as lockable handles.

Our one of a kind product takes it one step further in today's new energy saving standards worldwide. The unique high number of locking devices creates tightness throughout each component of the window. However, it doesn't stop there. The design enables the window to be tilted inwards to 20 degrees, which allows the proper flow through the side openings, while hot air escapes through the top opening. The tilt, turn and swing open function (180 degrees) operates by a simple single handle system.

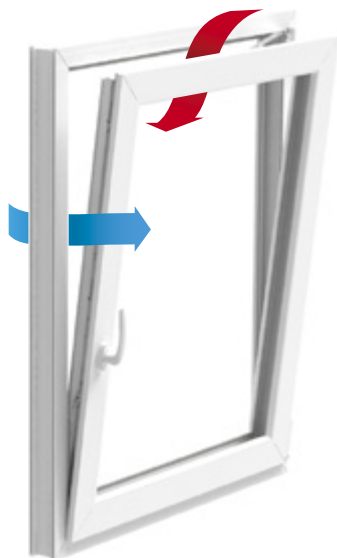

Window sizes 3ft x 3ft, utilize 14 Safety-bolts and 3 claws, a size of 3ft x 6ft min. utilize 18 Safety-bolts and 4 claws. All bolts are connected through a Rack and Pinion closed loop set up. Each bolt and fastener are interlocking with approximately 1763 pounds of leverage. One window and terrace door system that provides the maximum breach resistance, but also has the additional bonus of making the windows and terrace doors more energy saving efficient.

PM 14/18® | Module 2

Protection standard
for tilt-turn windows and terrace doors
with smash resistant windowpanes



The **PM 14/18®** Module 2 implements another unique safety feature with smash resistant windowpanes. Appropriate as well with lattice type glass.

The module 2 uses a pressed system of several panes together with intermediate plastic layers. Our product can be customized to fit the client's desired safety requirements. Additional features available include thermal absorbing, ornamental, and frosted glass finishes. All of our safety glazing features protects the client's property against breach, vandalism and unforeseen attacks.

Picture showing failed breach trial with 2 crowbars



PM 14/18® | Module 3

Protection standard for tilt-turn windows and terrace doors **with bullet resistant panes**



The **PM 14/18®** Module 3 introduces our highest protection in breach prevention.

The bullet resistant feature combined with our locking mechanism sets the industry standard for safety.



Glazing features:

- Switchable glass: clear to milky controlled by push button or remote control. Additional options available such as sensor control triggered by outside impact or bullet strikes.
- Glass with inside division of ledges.
- UV sun protection.

PM 14/18® | Module 4

Protection standard for tilt-turn windows and terrace doors **combined with sensor controlling**



The **PM 14/18®** Module 4 provides additional mechanical features to work along with alarm systems.

These additional features include lock/open controls of the safety bolts per window, and a glass break sensor. Our system can be used as a standalone system, or in conjunction with existing control boards. Fingerprint, code card, and other options are available as well on WLAN basis.

Consultation is Key – During the consulting process we determine the best module and glass feature combination based on each client's requirement. Utilizing our unique state of the art window technology, PM Shield provides top of the range safety, as well as making the windows more energy efficient.

Individual Shutter made the measure are also available on request.

IMPORTANT: due to technical and construction restrictions the use of some types of glass design may not be possible and will be specified during the consultation.

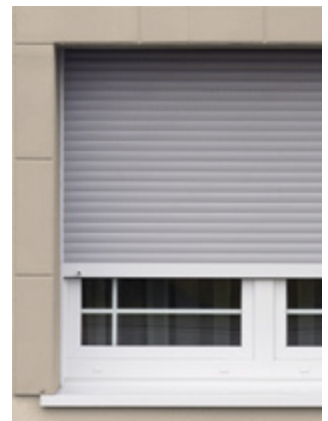

The **PM 14/18®** developed by the Schirmmacher Group is a product for existing and new windows and terrace doors with function and quality.

PM 14/18® is a proven high quality premium product certified through the IFT (European Institute for Windows and Doors) according to European standard DIN 18104. The **PM 14/18®** is equipped with "intelligent safety". The maximum number of safety bolts and locking claws (LOCK & HOLD TECHNOLOGY) makes the breaching much more difficult.

The **PM 14/18®** is recognized as essential to premium safety standards. Technical test have proven the protection system with a breach resistance of more than sixteen minutes. Test with additional safety glazing increased the time to forty five minutes. This will of course frustrate the efforts and despair well experienced intruders.

PM 14/18® Construction Fitting

The number of high performance safety bolts, claws and fasteners are determined by the window width and window height.

- 1 Fastener with corresponding safety bolt
- 2 Corner fitting
- 3 Corner fitting
- 4 Extension fitting
- 5 Handle gear
- 6 Corner fitting
- 7 Extension fitting
- 8 Locking claw

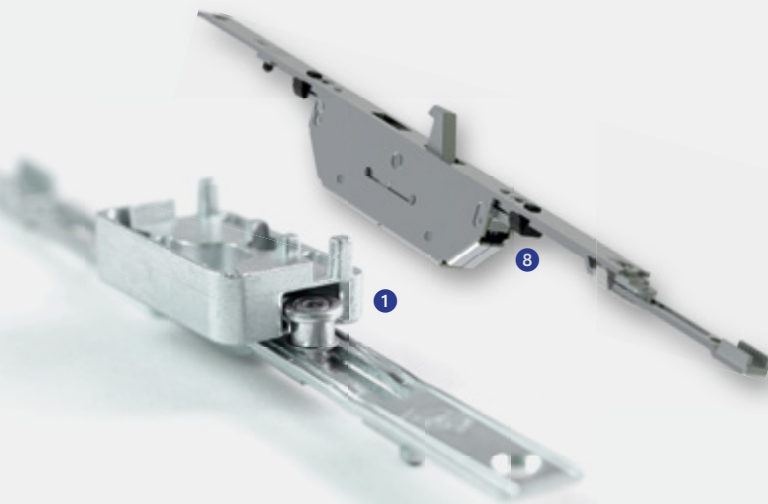

LOCK & HOLD TECHNOLOGY

During closing of the window with a single handle, all safety bolts and claws slide into their fastener simultaneously. The **PM 14/18®**, fitted with a closed loop system into the window, resists against a crow bar attack with more than 1763 pounds per each safety bolt.

Window (including double wing windows)

Example: Window size, 3ft width x 3ft height

A **minimum of 14** safety bolts and fastener, as well as a **minimum of 2** locking claws.

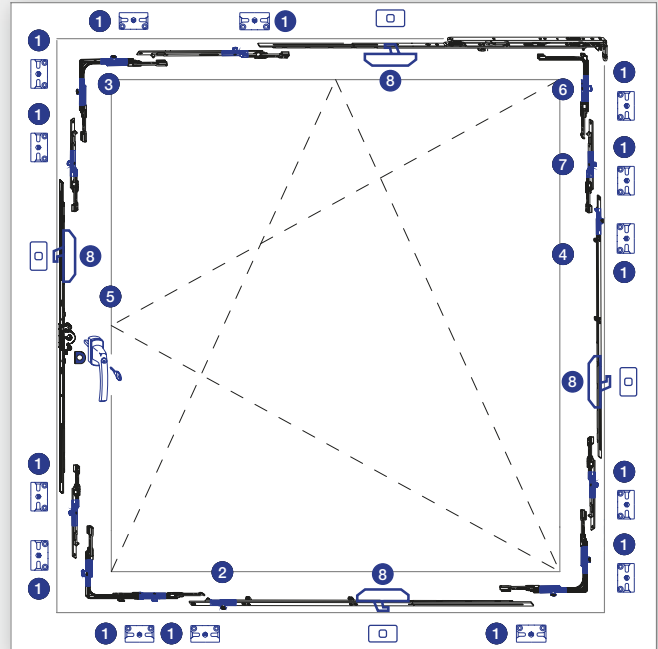

Terrace door (including double wing doors)

Example: Door size, 3ft width x 6ft height

A **minimum of 18** safety bolts and fastener, as well as a **minimum of 2** locking claws.

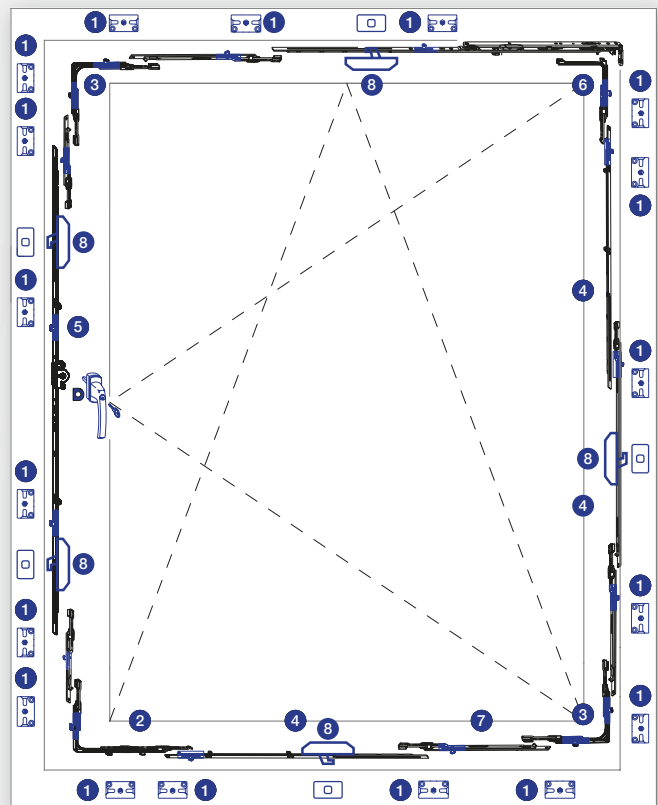

PM-SHIELD - A MEMBER OF THE SCHIRRMACHER-GROUP

Reliable LOCK & HOLD TECHNOLOGY

for mechanical protection.



Volker Schirmmacher
CEO

For more than twenty years, my primary mechanical engineering focus has been on the security of windows and terrace doors. As a specially trained and European certified expert, I have developed several mechanical safety solutions. The premium product of the Schirmmacher Group is the PM 14/18. The PM 14/18, as a part of the LOCK & HOLD TECHNOLOGY, is an invisible multi locking system also retrofitting all tilt turn windows and terrace doors.

The PM 14/18 fulfills the growing need in the public and private sector for enhanced security protection of family and assets.

The PM 14/18 has been designed and developed as a reinforced multi locking mechanism to deter an intruder's screwdriver or large crowbar.

Our specially designed technology is the standard for our company nationally and internationally.

The synergy of special safety glazing and/or electronic technology makes it almost impossible for intruders to overcome these protection shields.

The corporate purpose of the Schirmmacher Group is to further develop innovating technologies within the security and protection industry for homes and businesses.

PM-Shield LP offers protection solutions with breach resistant window

glazing, fixed and removable grids, breach resistant doors, windows, safety locks and security fittings.

Energy saving requirements are achieved by our high quality mechanical LOCK & HOLD TECHNOLOGY using clawed closures.

Breach Resistant Standards

Due to our extensive knowledge and experience as protection experts, we custom design a detailed plan for your security solutions.

Our Advantage – Qualified and Engaged Employees

The quality and technical competence of our company is due to our valued employees. All of our skilled carpenters and mechanics complete a thorough and vigorous training program. Completion of the training program provides our employees with the knowledge and skills of a master in the mechanical protection field.

Our Vision – Market leader in mechanical protection for ALL homes and businesses

We want to help every citizen protect his or her homes against intruders, because ...

“PROTECTION IS OUR PASSION.”

History

1995 – Volker Schirmmacher established Schirmmacher Sicherheitstechnik to professionally maintain and repair doors and windows based on the manufacture. The research and development enabled the first German approved concept of consulting and retrofitting invisible and breach resistant mechanisms for doors and windows.

1998 – Certification of Schirmmacher Corporation from the Berlin DIN Office as Germany's first company for expert mechanical retrofitting.

2001 – Chamber of Crafts public announcement that Volker Schirmmacher is Germany's first recognized expert in mechanical protection for doors and windows.

2002 – Certification of Schirmmacher Corporation from the IFT (European Institute for Window and Door Certification) as an expert company for mechanical retrofitting.

2004–2011 – Opening of Schirmmacher Inc. office, Frankfurt/Munich.

2005 – Certification of Schirmmacher Corporation by the VDS (German Association of the German Insurance Industry) as an expert for mechanical retrofitting.

2007 – Schirmmacher Corporation acquired the German company Schutz & Sicherheit Inc., Munich Germany.

2011 – Merger of Schirmmacher Inc., Frankfurt and the Schutz & Sicherheit Inc. Munich to become Schirmmacher Schutz & Sicherheit LP, Frankfurt/Munich.

2012 – Market introduction of the invisible protection system PM 14/18® for windows and terrace doors by Schirmmacher.

2013 – Certification of Schirmmacher Schutz & Sicherheit LP, Frankfurt by IFT (European Institute for Window and Door Certification) as an expert in mechanical retrofitting.

2014 – Berlin opening of Schirmmacher service office, capital of Germany.

2016 – Dresden opening of Schirmmacher service office, east Germany.

2016 – PM-Shield LP, Atlanta GA USA established by Volker Schirmmacher.

2017 – Idar-Oberstein opening of Schirmmacher service office, west



FRANKFURT



BERLIN



DRESDEN



Schirmmacher Company Headquarter and Training center, Nümbrecht, Germany

PROTECTION IS OUR PASSION

PM-SHIELD LP
 USA Headquarter
 5126 S. Royal Atlanta Dr.
 Tucker, GA 30084, USA

Tel.: +1 770 274 2408
 Fax: +1 770 934 3348
 info@pm-shield.com

Representative Office Germany
Schirmmacher Schutz & Sicherheit GmbH & Co. KG
 Pfaffenwiese 47b
 65931 Frankfurt/M.

Tel.: +49 69 3006 5576
 info@schutz-und-sicherheit.de
 schirmmacher-gruppe.de

pm-shield.com